

KITCHEN SINK

KS1176SS12SS



Description

- 304 Stainless Steel
- 16 Gauge
- Zero Radius corners
- 24"x18"x8"
- Sound deadening pads on sides and bottom of Sink

Codes/Standards Applicable

Specified model meets or exceeds the following:

- ASME A112.19.3

Colors/Finishes

- Stainless Steel

KITCHEN SINK
KS1176SS12SS

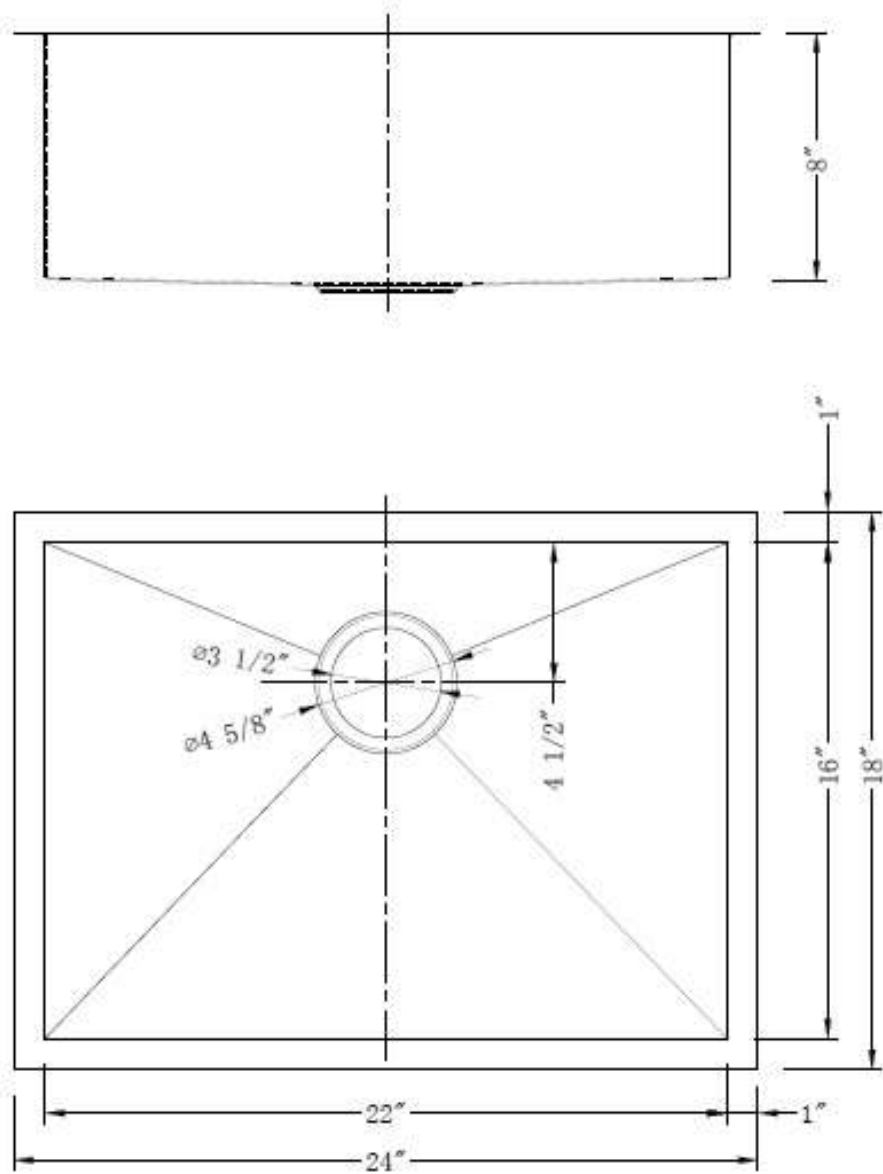

Product Diagram