

KITCHEN SINK

KS1131SS12SS



Description

- 304 Stainless Steel
- 16 Gauge
- Rounded Corners 3/8" Radius
- 27" X 18" X 9"
- Sound deadening pads on sides and bottom
- Strainer included

Codes/Standards Applicable

Specified model meets or exceeds the following:

- ASME A112.19.3

Colors/Finishes

- Satin Finish
- Mirror Finish

KITCHEN SINK
KS1131SS12SS

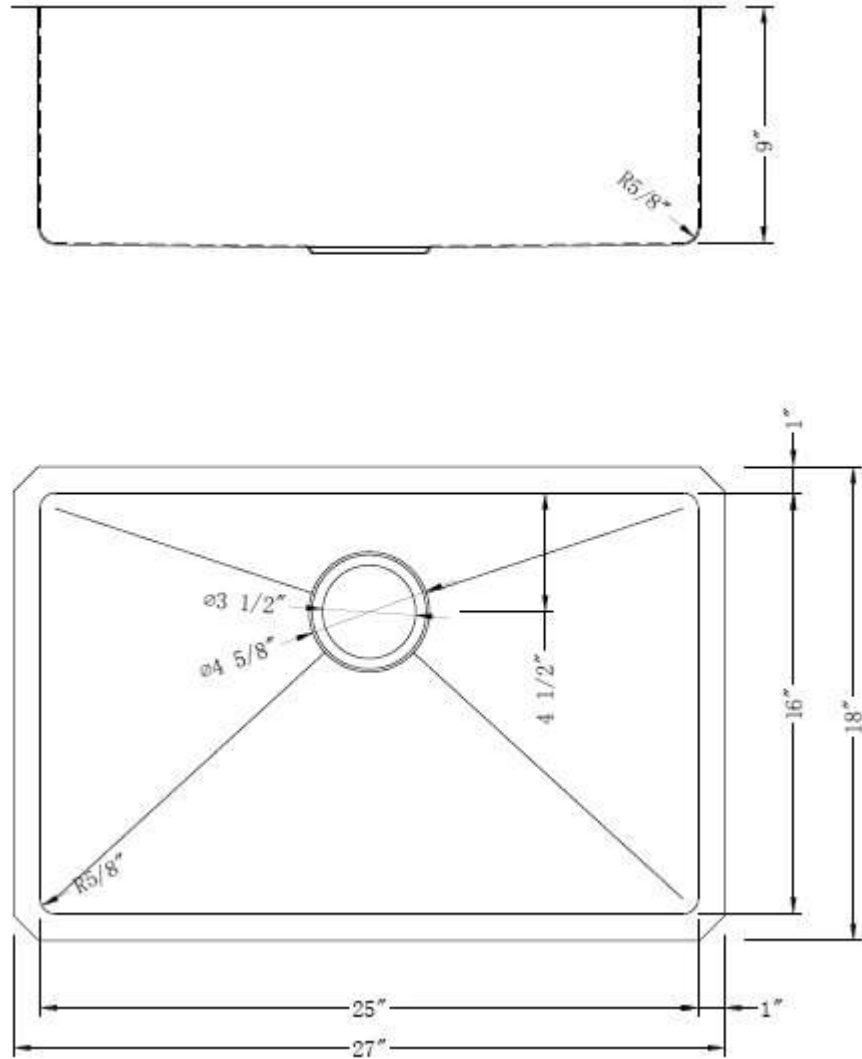

Product Diagram