

TUB & SHOWER TRIM
STWOD1105BR8PC



Description

- Solid Brass Material
- Single lever

Codes/Standards Applicable

Specified model meets or exceeds the following:

- ASME/ANSI A112.18.1M
- ADA Compliant

Colors/Finishes

- Polished Chrome
- Brushed Chrome
- Polished Nickel
- Satin Nickel

TUB & SHOWER TRIM
STWOD1105BR8PC

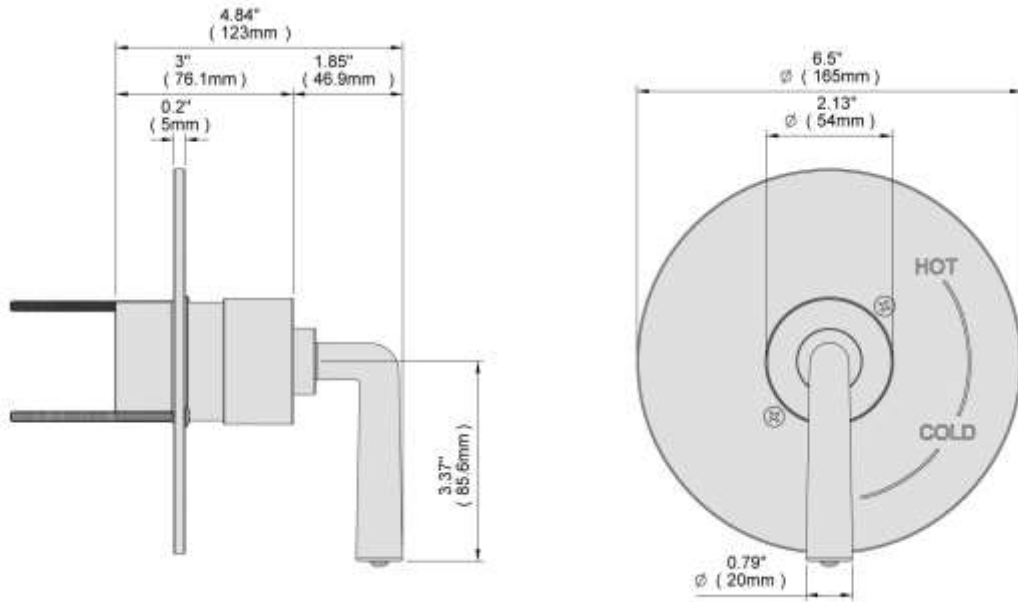

Product Diagram