

LAVATORY FAUCET
LF1268BR2PC



Description

- Brass Material

Codes/Standards Applicable

Specified model meets or exceeds the following:

- ASME A112.18.1
- ADA Compliant
- 1.5 GPM at 60 PSI

Colors/Finishes

- Polished Chrome
- Brushed Chrome
- Polished Nickel
- Satin Nickel

LAVATORY FAUCET
LF1268BR2PC

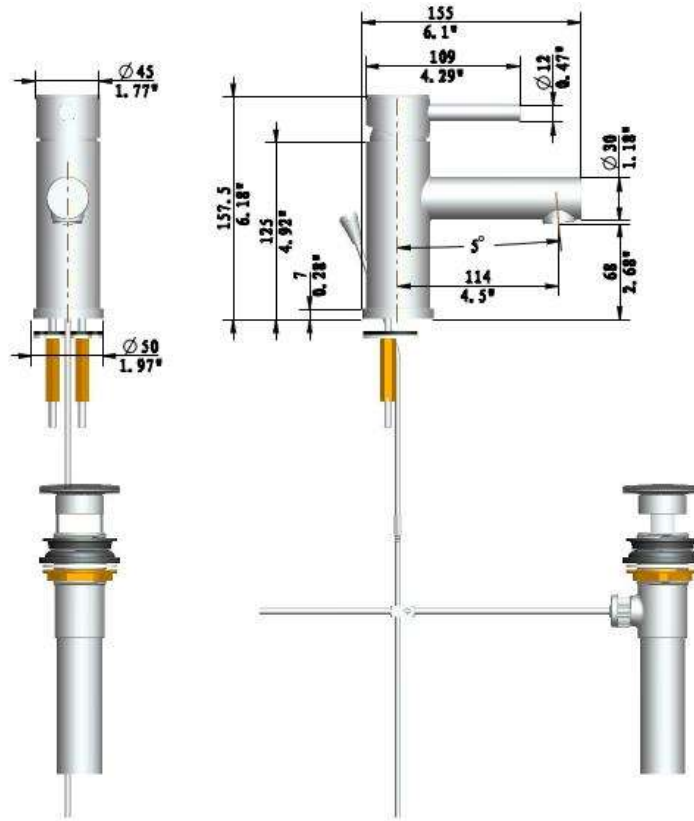

PRODUCT DIAGRAM