

Diverter Trim
DT1027BR13PC



Description

- Solid Brass Material
- Single Lever Handle

Codes/Standards Applicable

Specified model meets or exceeds the following:

- ASME/ANSI A112.18.1M
- ADA Compliant

Colors/Finishes

- Polished Chrome
- Brushed Chrome
- Polished Nickel
- Satin Nickel

Diverter Trim
DT1027BR13PC

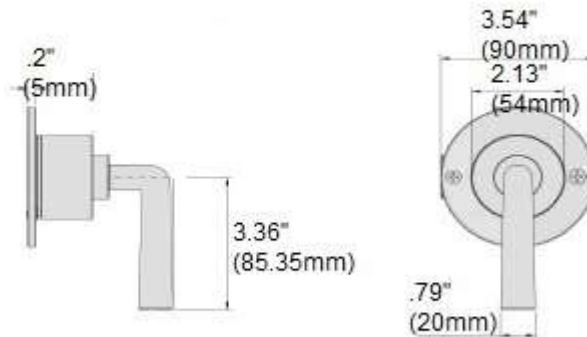

Product Diagram