

KITCHEN SINK

KS1087SS12SS



Description

- 304 Stainless Steel
- 16 Gauge
- Zero Radius Corners
- 15"x20"x10"
- Sound deadening pads on sides and bottom

Codes/Standards Applicable

Specified model meets or exceeds the following:

- ASME A112.19.3

Colors/Finishes

- Satin Finish

KITCHEN SINK
KS1087SS12SS

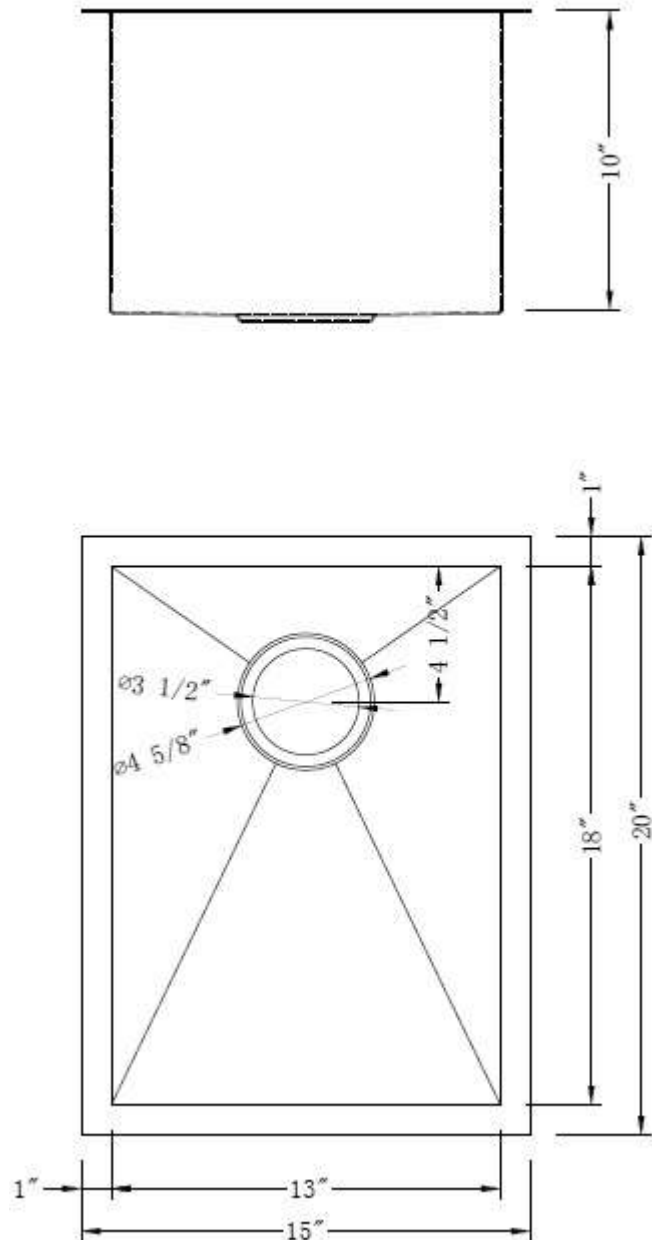

Product Diagram