

KITCHEN SINK
KS1050SS12SS



Description

- 304 Stainless Steel
- 18 Gauge
- Rounded corners
- 23"x18"x8"
- Sound deadening pads on sides and bottom

Codes/Standards Applicable

Specified model meets or exceeds the following:

- ASME A112.19.3

Colors/Finishes

- Satin Finish
- Mirror Finish

KITCHEN SINK
KS1050SS12SS

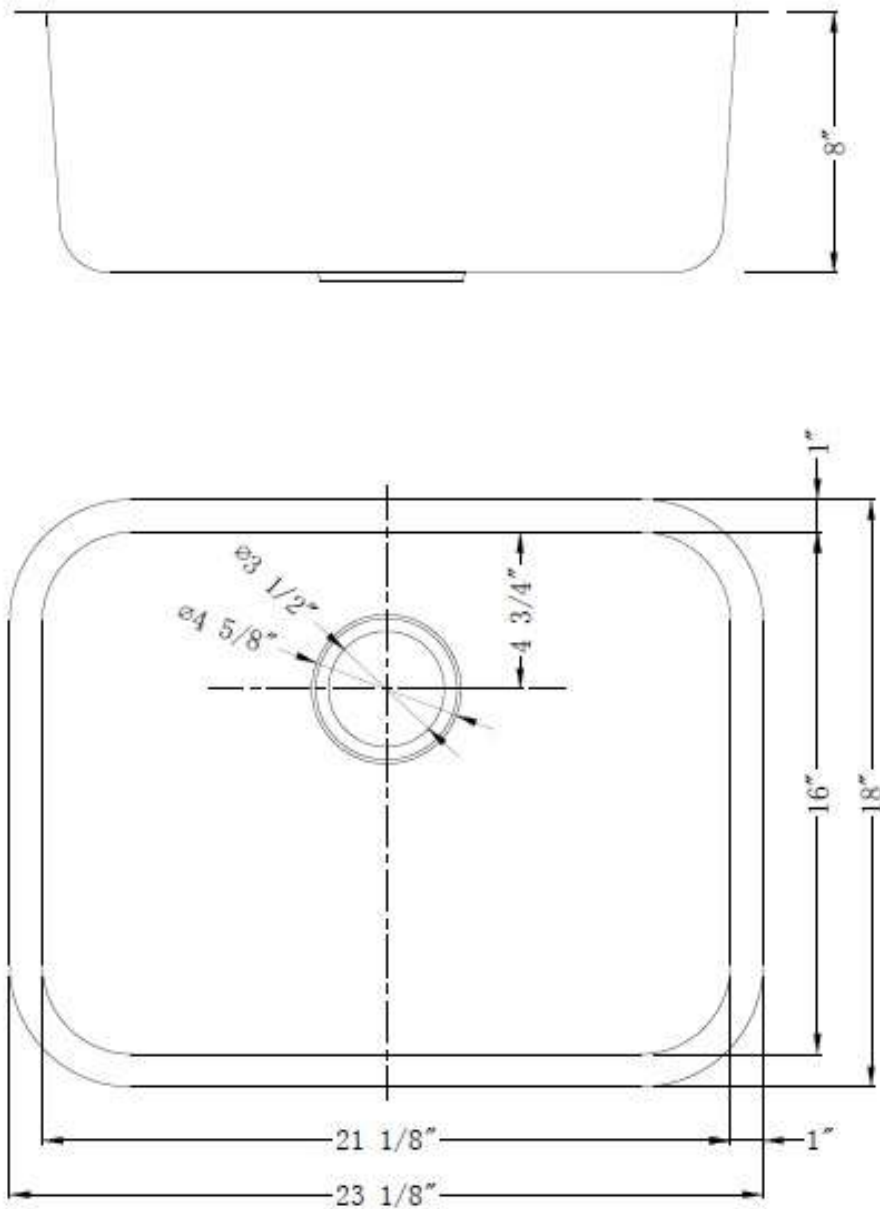

Product Diagram